



Outperform every day.™

Project:

Item Number:

Quantity:

MODUSERV® MODULAR DISPENSER SYSTEM



MRBM-1

MRBM-2



MRBM-3

ModuServ® Modular Dispenser System

DESCRIPTION

The compact ModuServ® Dispenser System receptor boxes are designed for in-counter installation. Three sizes accept a variety of components to create custom dispensing stations. Slots hold components firmly in place.

MODELS

MRBM-1 Small Receptor Box with Faceplate







MRBM-2 Medium Receptor Box with Faceplate

MRBM-3 Large Receptor Box with Faceplate

FEATURES

- Impact-resistant molded thermoplastic construction
- Finish is mar and fingerprint resistant
- Receptor boxes include mounting screws
- Components insert without tools for easy re-arrangement
- Clear faceplate secures components in place and removes for cleaning

COMPONENTS

-  **MCM-1** Condiment/Creamer Divider
-  **MLM-1** Lid Divider
-  **MN-1** Napkin Dispenser - Accommodates 6½" x 3½" (16.3 x 8.9 cm) Folded Napkin
-  **MN-2** Napkin Dispenser - Accommodates 6½" x 5" (16.5 x 12.7 cm) Folded Napkin
-  **MS-1A** One-at-a-Time Bulk Straw Dispenser - Accommodates straws up to 8" (20.3 cm)
-  **MS-2A** One-at-a-Time Stir Stick Dispenser - Accommodates stir sticks up to 5½" (14 cm)
-  **MW-1** Waxed Tissue Dispenser - Accommodates most mini-size cartons

WARRANTY: All models shown come with Vollrath's standard warranty against defects in materials and workmanship. For full warranty details, please refer to the Vollrath Equipment and Smallwares Catalog.

Approvals	Date

Due to continued product improvement, please consult www.vollrath.com for current product specifications.



Outperform every day.™
www.vollrath.com

The Vollrath Company, L.L.C.
1236 North 18th Street
Sheboygan, WI 53081-3201 U.S.A.
Customer Service: 800.628.0830
Canada Customer Service: 800.695.8560
Main Fax: 800.752.5620 or 920.459.6573

Technical Services: 800.628.0832
Technical Services Fax: 920.459.5462

MODUSERV® MODULAR DISPENSER SYSTEM

MODELS MRBM-1 Small Receptor Box with Faceplate
MRBM-2 Medium Receptor Box with Faceplate

MRBM-3 Large Receptor Box with Faceplate

DIMENSIONS (Shown in inches (cm))

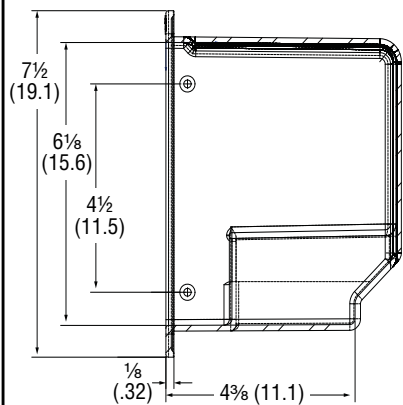

Side View - All Models

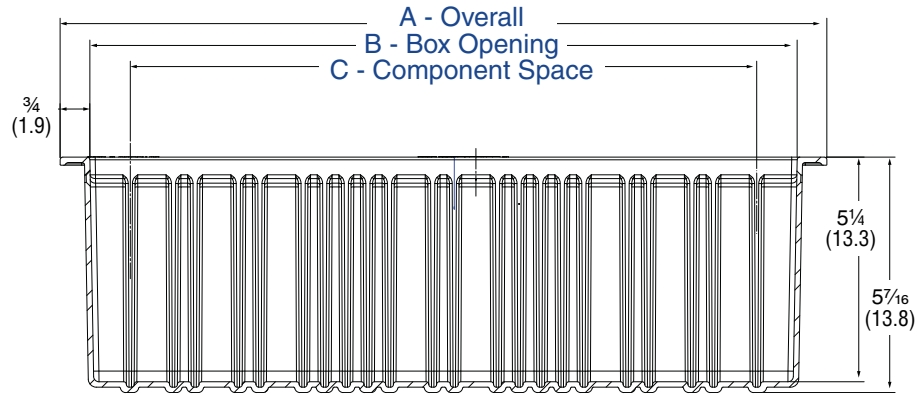

Top View - All Models
MRBM-2 Shown

SPECIFICATIONS

Item	Dimensions IN (CM)			Cutout Size
	(A)	(B)	(C)	
MRBM-1	10 ³ / ₄ (27.3)	9 ³ / ₈ (23.8)	7 (17.8)	6 ⁹ / ₁₆ X 9 ¹¹ / ₁₆ (16.7 X 24.6)
MRBM-2	17 ³ / ₄ (45.1)	16 ³ / ₈ (41.6)	14 ¹ / ₂ (36.8)	6 ⁹ / ₁₆ X 16 ¹¹ / ₁₆ (16.7 X 42.4)
MRBM-3	22 ¹ / ₄ (56.5)	20 ⁷ / ₈ (53)	19 (48.3)	6 ⁹ / ₁₆ X 21 ³ / ₁₆ (16.7 X 53.8)
Component	Height	Width	Depth	Cutout Size
MCM-1 - Condiment/ creamer divider	6 (15.3)	1 ¹ / ₈ (.32)	6 ³ / ₈ (16.2)	-
MLM-1 - Lid divider	6 (15.3)	1 ¹ / ₈ (.32)	6 ³ / ₈ (16.2)	-
MN-1 - Napkin dispenser	6 ¹ / ₄ (15.9)	7 ¹ / ₈ (18.1)	6 ¹ / ₄ (15.9)	-
MN-2 - Napkin dispenser	5 ¹ / ₄ (13.3)	8 ¹ / ₂ (21.6)	5 ⁷ / ₁₆ (11.3)	-
MS-1A - Straw dispenser	6 (15.3)	8 ⁵ / ₈ (21.9)	5 ¹ / ₈ (13)	-
MS-2A - Stir stick dispenser	6 (15.3)	7 ¹ / ₈ (18.1)	5 ¹ / ₈ (13)	-
MW-1 - Waxed tissue dispenser	6 ¹ / ₄ (15.9)	7 ³ / ₁₆ (18.3)	5 ¹ / ₈ (13)	-

Front Views

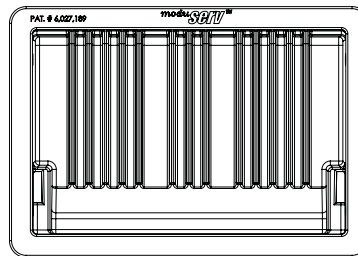

MRBM-1

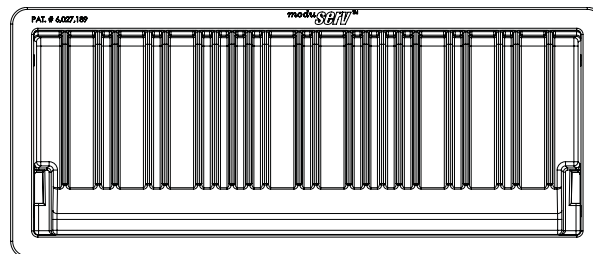

MRBM-2

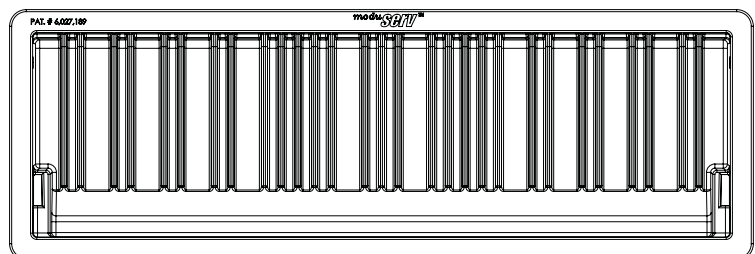

MRBM-3



Outperform every day.™

www.vollrath.com

The Vollrath Company, L.L.C.
1236 North 18th Street
Sheboygan, WI 53081-3201 U.S.A.
Customer Service: 800.628.0830
Canada Customer Service: 800.695.8560
Main Fax: 800.752.5620 or 920.459.6573

Technical Services: 800.628.0832
Technical Services Fax: 920.459.5462