



Project:

Item Number:

Quantity:

CAYENNE® HEAVY-DUTY INDUCTION HOT PLATES



912HIMC



924HIMC



912HIDC



924HIDC

Cayenne® Heavy-Duty Induction Hot Plates

DESCRIPTION

These high-efficiency, heavy-duty, commercial, bench top induction hot plates are designed for use in commercial kitchens. They provide sensitive low-end control for cooking sauces, milks and chocolates as well as fast, high temperature cooking.

The induction hot plates come complete with one or two 30 amp power cords with plugs (see Specifications). The case is made from 18-gauge 304 stainless steel with a vitro ceramic top. The ceramic top is easily cleaned with a mild cleaner.

The induction range is equipped with a variety of safety features including:

- Over-heat protection
- Small-article detection
- Pan auto-detection function
- Empty-pan shut-off

Agency Listings



This device complies with Part 18 FCC Rules.

Due to continued product improvement, please consult www.vollrathco.com for current product specifications.

MODELS

912HIMC Dual Hob, Manual Control (US/Canada)

912HIDC Dual Hob, Digital Control (US/Canada)

924HIMC Four Hob, Manual Control (US/Canada)

924HIDC Four Hob, Digital Control (US/Canada)

FEATURES

- G4 4 IGBT Engine
- Stainless steel framed hobs
- Firewall control protection
- Dual commercial, high-flow fans for extra durability
- 90% efficiency rating
- Low 100°F temperature setting for holding applications
- Same look and operating height as Cayenne® charbroilers and griddles
- FCC Part 18 approved
- Adjustable legs for leveling
- Rubber feet to prevent slipping
- One year parts and labor warranty

Manual Control Models

- Knob power control, from 1% to 100%
- Knob guards

Digital Control Models

- Multi-sensor solid-state controls with digital display
- Smooth power control from 1% to 100% of output power and temperature control settings in Fahrenheit only
- Push button controls for easy cleaning
- 1 to 180 minute timer

IMPORTANT

- This appliance is intended for use with induction-ready cookware.
- All models require a minimum ½" clearance between the induction unit and any adjacent hot equipment, such as charbroilers or griddles (do not install flush). Unit draws air from below. Do not install in areas where other equipment can exhaust directly into the induction range.
- The maximum intake temperature must not exceed 110°F (43°C). Temperatures are measured in ambient air while all appliances in the kitchen are in operation.

WARRANTY: All models shown come with Vollrath's standard warranty against defects in materials and workmanship. For full warranty details, please refer to the Vollrath Equipment and Smallwares Catalog.

Approvals	Date



Setting the Standard™

www.vollrathco.com

The Vollrath Company, L.L.C.
1236 North 18th Street
Sheboygan, WI 53081-3201 U.S.A.
Customer Service: 800.628.0830
Canada Customer Service: 800.695.8560
Main Fax: 800.752.5620 or 920.459.6573

Technical Services: 800.628.0832
Technical Services Fax: 920.459.5462

CAYENNE® HEAVY-DUTY INDUCTION HOT PLATES

MODELS	912HIMC	Dual Hob, Manual Control (US/Canada)	924HIMC	Four Hob, Manual Control (US/Canada)
	912HIDC	Dual Hob, Digital Control (US/Canada)	924HIDC	Four Hob, Digital Control (US/Canada)

DIMENSIONS

Dimensions shown in inches (cm).

Dual Hob 912HIMC / 912HIDC

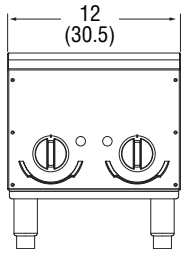

Front View

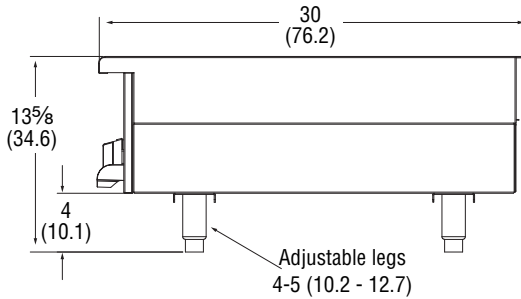

Side View

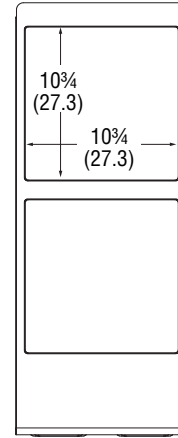

Top View

Four Hob 924HIMC / 924HIDC

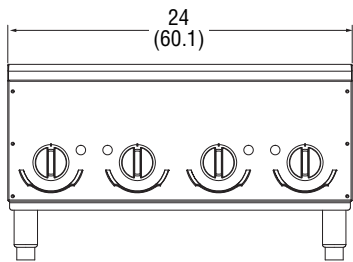

Front View

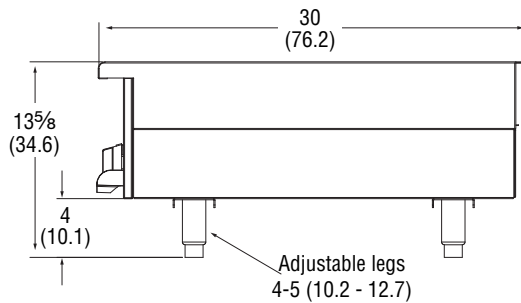

Side View

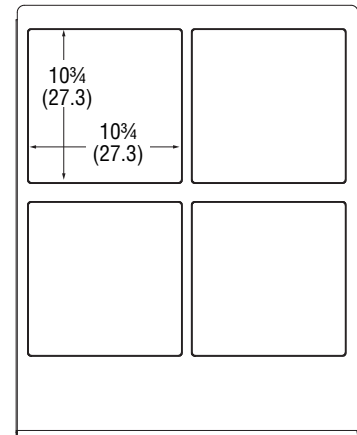

Top View

ELECTRICAL SPECIFICATIONS

Item	Volts	HZ	Amps	Watts per Hob	Net Weight lb (kg)	Plug
912HIMC	208-240V AC	50/60	24	2500-2900	47 (21.3)	6-30P
912HIDC	208-240V AC	50/60	24	2500-2900	47 (21.3)	6-30P
924HIMC	208-240V AC	50/60	2 x 24	2500-2900	86 (39)	2 x 6-30P
924HIDC	208-240V AC	50/60	2 x 24	2500-2900	86 (39)	2 x 6-30P

Dual hob units feature one power cord and require a single receptacle with a dedicated circuit.
Four hob units feature two power cords and require two outlets, each with a dedicated circuit.

Receptacle

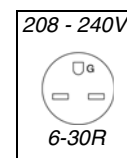

www.vollrathco.com

The Vollrath Company, L.L.C.
1236 North 18th Street
Sheboygan, WI 53081-3201 U.S.A.
Customer Service: 800.628.0830
Canada Customer Service: 800.695.8560
Main Fax: 800.752.5620 or 920.459.6573

Technical Services: 800.628.0832
Technical Services Fax: 920.459.5462